

# Vibration Control System

## *S-2000 Stabilizer™ Vibration Isolators and Optical Table Installation Manual*



User's Manual



**Newport®**

Experience | Solutions



---

## Warranty

Newport Corporation warrants that this product will be free from defects in material and workmanship and will comply with Newport's published specifications at the time of sale for a period of one year from date of shipment. If found to be defective during the warranty period, the product will either be repaired or replaced at Newport's option.

To exercise this warranty, write or call your local Newport office or representative, or contact Newport headquarters in Irvine, California. You will be given prompt assistance and return instructions. Send the product, freight prepaid, to the indicated service facility. Repairs will be made and the instrument returned freight prepaid. Repaired products are warranted for the remainder of the original warranty period or 90 days, whichever first occurs.

### Limitation of Warranty

The above warranties do not apply to products which have been repaired or modified without Newport's written approval, or products subjected to unusual physical, thermal or electrical stress, improper installation, misuse, abuse, accident or negligence in use, storage, transportation or handling. This warranty also does not apply to fuses, batteries, or damage from battery leakage.

**THIS WARRANTY IS IN LIEU OF ALL OTHER WARRANTIES, EXPRESSED OR IMPLIED, INCLUDING ANY IMPLIED WARRANTY OF MERCHANTABILITY OR FITNESS FOR A PARTICULAR USE. NEWPORT CORPORATION SHALL NOT BE LIABLE FOR ANY INDIRECT, SPECIAL, OR CONSEQUENTIAL DAMAGES RESULTING FROM THE PURCHASE OR USE OF ITS PRODUCTS.**

First printing 2009

© 2009 by Newport Corporation, Irvine, CA. All rights reserved. No part of this manual may be reproduced or copied without the prior written approval of Newport Corporation.

This manual has been provided for information only and product specifications are subject to change without notice. Any change will be reflected in future printings.

Newport Corporation  
1791 Deere Avenue  
Irvine, CA, 92606 USA

---

# Table of Contents

Warranty.....	iii
Table of Contents .....	iv
List of Figures .....	vi
<b>1 General Information</b>	<b>1</b>
1.1 Introduction .....	1
1.2 Getting Started.....	1
1.3 Unpacking and Inspecting .....	1
1.4 Safety Considerations.....	2
1.5 Table Placement .....	2
1.6 Air Supply Requirements .....	3
1.7 Warranty Information.....	4
<b>2 Assembly</b>	<b>5</b>
2.1 Assembling the System .....	5
2.1.1 Table Installation Assistance.....	5
2.1.2 Positioning the Isolators .....	5
2.1.3 Installing Table Top .....	6
2.2 Leveling the Table.....	7
2.3 Isolating the Table Top.....	8
2.3.1 Installing Leveling Valves.....	8
2.3.2 Connecting Air Lines .....	10
2.3.3 Adjusting Leveling Valve Sensors .....	13
2.4 Installing tables with the Doubler Interface .....	14
<b>3 Operation</b>	<b>17</b>
3.1 Principles of Operation.....	17
3.2 Performance Adjustments .....	17
3.3 Maintenance .....	18
3.3.1 Cleaning.....	18
3.3.2 Air Quality.....	19
<b>4 Troubleshooting</b>	<b>20</b>
4.1 Table Top Does Not Float .....	20
4.2 Poor Isolation Performance .....	20

---

4.3	Table Top Oscillates.....	21
4.4	System Leaks Air Constantly .....	21
4.5	Oil Leak From Isolator .....	21
4.6	Adding Damping Oil .....	21

---

<b>5</b>	<b>Factory Service</b>	<b>23</b>
----------	------------------------	-----------

---

---

## List of Figures

Figure 1	— Isolator Position .....	5
Figure 2	— Isolator Clamps and Mounting Holes .....	6
Figure 3	— Isolator Leveling Wrench .....	7
Figure 4	— Level Adjustment of Isolators.....	7
Figure 5	— IPV Leveling Valve .....	9
Figure 6	— Valves attaching to isolator.....	9
Figure 7	— Orientation of Control Arm .....	10
Figure 8	— Air Line Routing .....	11
Figure 9	— Detail of Valve Connections, Single Isolator .....	12
Figure 10	— Detail of Valve Connections, Two Isolators.....	12
Figure 11	— Floating Height Adjustment and centering .....	14
Figure 12	— Typical Double Interface System.....	14
Figure 13	— Double Bolt Tightening Sequence .....	16
Figure 14	— System Stability .....	18

---

# 1 General Information

## 1.1 Introduction

---

The Newport Vibration Control System provides an ideal working platform for vibration sensitive devices such as interferometers, microscopes, and balances. The table surface is isolated from floor motion using the Stabilizer™ pneumatic suspension system. The versatile Newport Vibration Control System is available in a variety of sizes, working surfaces, and options.

These systems integrate Newport's rigid, laminated honeycomb panel technology and pneumatic isolation systems to provide a mounting platform which is rigid, yet thin and light weight.

It is possible to tailor the system to a wide variety of applications using the entire range of sizes and working surfaces. A typical Newport Vibration Control System consists of an optical table and vibration isolators.

The S-2000 Stabilizer™ isolation system is capable of supporting 2000 pounds per isolator. Caution must be observed to ensure that heavy payloads are not located off center on the table surface. This could cause overloading of one isolator even though the average load per isolator is below the 2000 pound limit.

## 1.2 Getting Started

---

Heavy payloads with very high centers of gravity (C-G) may cause the isolation system to oscillate. Please consult Section 3.2 of this manual or Newport Applications Engineering for high C-G applications.

Please read this instruction manual thoroughly before assembling the table system. The individual components have been assembled at the factory and require only final system assembly and performance adjustment.

## 1.3 Unpacking and Inspecting

---

The components of your Newport Vibration Control System are packed in individual, labeled boxes. Be sure the number of boxes you received is equal to the total number listed on the label (for example, if a box is labeled 1 of 4, there should be 4 boxes).

---

## 1.4 Safety Considerations

---

Carefully inspect all components for shipping damage. Report any shipping damage immediately to the shipping company and Newport.

The following terms are used in this manual that relate to your safety.

	<p style="text-align: center;"><b>WARNING</b></p> <p>Warning is used to indicate dangers that could result in personal injury.</p>
---	--

	<p style="text-align: center;"><b>CAUTION</b></p> <p>Caution is used to indicate situations that may result in damage to components of your Newport Vibration Control System.</p>
---	---

## 1.5 Table Placement

---

To ensure optimal performance from your Vibration Control System, it should be located on a level surface. Uneven floors may cause difficulty during the leveling of the table top if their irregularity is outside of the adjustment range of the isolators.

The S-2000 Stabilizer™ isolator must be mounted so that its axis is not more than 0.5 degrees from vertical. This is necessary for the isolator to function properly in the horizontal mode. Note: 0.5 degrees is equal to 0.09 (2.2 mm) inches in 10.0 inches which is the isolator base diameter. A typical spirit level will easily measure 0.5 degrees and can be used to check the vertical alignment of each isolator.

If the floor where the isolators are being mounted has a depression of more than 0.09 inches under one side of the base, then the floor should be grouted or shimmed level at this location.

If the system is not located on the ground floor of the building, it should be located near primary vertical structures such as exterior walls or support columns. By locating the table near these structures, the effects of low frequency floor motion will be minimized, thus increasing the performance of the table. It is also advisable to avoid locations adjacent to major sources of vibration from operating machinery such as elevators, air conditioning plants, or factory equipment.





### WARNING

The table top is attached to the isolators with clamps and hex head bolts. In the event of an earthquake, the table may collapse. For areas susceptible to earthquakes, we recommend that Newport Earthquake Restraints be installed on each Vibration Control System.



### WARNING

The table top is a metallic electrical conductor. For installations where electrical shock is a possibility, the table top should be grounded to prevent personal injury.

## 1.6 Air Supply Requirements

A constant supply of air must be connected to the Vibration Control System during operation. After initial setup and filling, the isolators consume air only when the leveling valves adjust the pressure to compensate for changes in the load on the table.

Bottled nitrogen or mechanically compressed air may be used. The required pressure is determined by dividing the total load, including table weight, by the total isolator diaphragm area (25.9 in<sup>2</sup> per isolator) plus 5-10 psig.

For example, if the table plus load is 2850 pounds and will be mounted on 4 isolators, the required pressure is:

$$\frac{2850 \text{ lbs}}{4 \times 25.9 \text{ in}^2} + 10 \text{ psig} = 37.5 \text{ psig}$$

Note that the maximum operating pressure for the system is 95 psig (6.7 kg/cm<sup>2</sup>).

The Newport Model ACGP air compressor is an extremely quiet source of clean, pressure regulated air. If another compressor or plant air is used, the Newport model ARF Air Regulator Filter should be used to ensure maintenance free operation. These filters prevent water and dirt from getting into the leveling valves and causing the valves to fail due to clogging.

The supply should include a valve so that the air may be shut off during maintenance or extensive setup when the load is changed drastically.



### CAUTION

Bottled carbon dioxide (CO<sub>2</sub>) is not recommended since "icing" can occur during rapid filling of the isolators.

---

## **1.7      Warranty Information**

---

Warranty information may be found on the page preceding the Table of Contents in this manual. Should it become necessary to exercise the warranty, contact your Newport representative to determine the proper course of action. Newport Corporation maintains offices throughout the United States and other locations worldwide.

## 2 Assembly

### 2.1 Assembling the System

#### 2.1.1 Table Installation Assistance

Optical tables are heavy. Even a small table top weighs over 500 pounds (227 Kg). Contact Newport or your local sales representative for help in preparing your facility.

#### 2.1.2 Positioning the Isolators

Figure 1 shows the correct isolator positions for standard table sizes. Table 1 shows the correct dimensions (A, B, & C) for each table size.

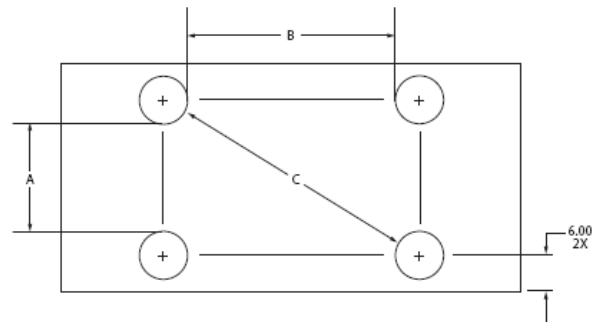

Figure 1 — Isolator Position

Table Width ft (mm)	Table Length ft (mm)	A in (mm)	B in (mm)	C in (mm)
3 (900)	6 (1800)	14 (341)	30 (733)	35.5 (899)
3 (900)	8 (2400)	14 (341)	42 (1028)	47.25 (1159)
3 (900)	10 (3000)	14 (341)	56 (1374)	60.25 (1479)
4 (1200)	6 (1800)	14 (341)	30 (733)	43.75 (1079)
4 (1200)	8 (2400)	26 (641)	42 (1028)	52.25 (1310)
4 (1200)	10 (3000)	26 (641)	56 (1374)	65.25 (1604)
4 (1200)	12 (3600)	26 (641)	70 (1720)	77.75 (1914)
4 (1200)	14 (4200)	26 (641)	84 (2166)	90.75 (2326)
4 (1200)	16 (4800)	26 (641)	94 (2311)	100 (2463)
5 (1500)	6 (1800)	38 (941)	30 (733)	51.75 (1296)
5 (1500)	8 (2400)	38 (941)	42 (1028)	60 (1499)
5 (1500)	10 (3000)	38 (941)	56 (1374)	71 (1766)
5 (1500)	12 (3600)	38 (941)	70 (1720)	82.75 (2054)
5 (1500)	14 (4200)	38 (941)	84 (2166)	95 (2445)
5 (1500)	16 (4800)	38 (941)	94 (2311)	104.25 (2576)

Table 1 — Isolator Positions

### 2.1.3 Installing Table Top

If your table is equipped with a Doubler Interface be sure to follow the instructions in Section 2.4 for assembling the table sections prior to installing them on the isolators.



#### WARNING

**Table tops are heavy! Use a forklift or other appropriate equipment. Be sure to use proper lifting procedures to avoid severe personal injury.**

1. With the isolators located as described in Section 2.1.2, raise the table top and position it above the isolators. Be sure each isolator is centered within the tapped three-hole patterns on the lower surface of the table (Figure 2).

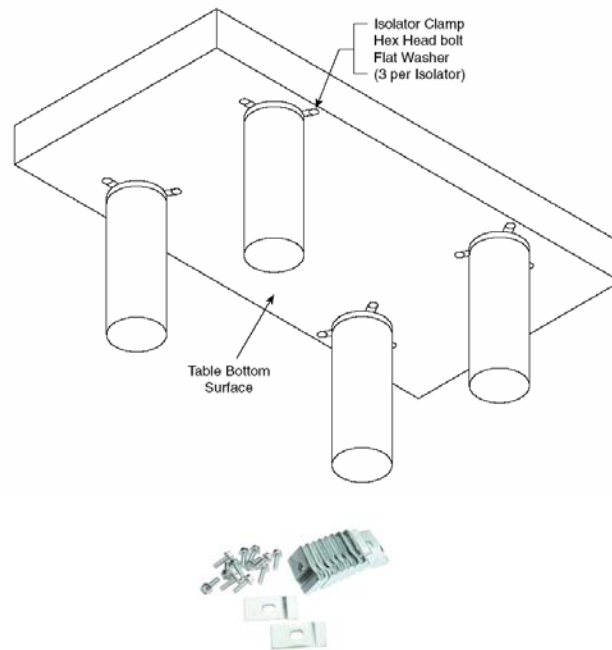



Figure 2 — Isolator Clamps and Mounting Holes

2. Gently lower the table so that it is just above the top of isolators.
3. Install three isolator clamps in the corners where each isolator is located (Figure 2). Loosely secure the clamps with the bolts. Do not tighten the clamps at this time.
4. Lower the table top until it rests on the isolator support plates.

	<p style="text-align: center;"><b>CAUTION</b></p> <p>When lowering the table on to the supports, do not allow the table to shift sideways. Doing so could damage the isolators and cause degradation in performance.</p>
---	--

## 2.2 Leveling the Table

Use the following procedure to level the table. The special wrench (Figure 3) is for all adjustments.

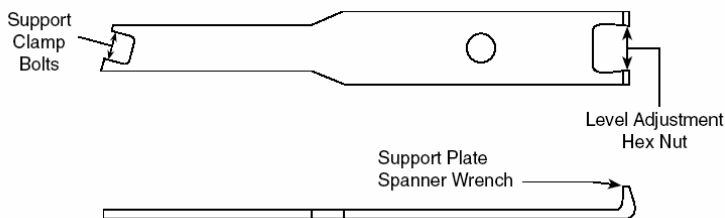

Figure 3 — Isolator Leveling Wrench

1. Refer to Figure 4. As shown, use one of the special wrenches to hold the hex nut stationary. Insert the prongs of the second wrench into the holes on the bottom of the support plate. Rotate the plate using the top wrench to adjust the height.
2. Place a level on the table top, approximately in the center.
3. For each isolator, adjust the support plates as required to bring the table to a level condition. Be sure to check the level using both the length and width axes of the table. Verify that the centering disks are centered in and resting on their respective guides (Figure 4).

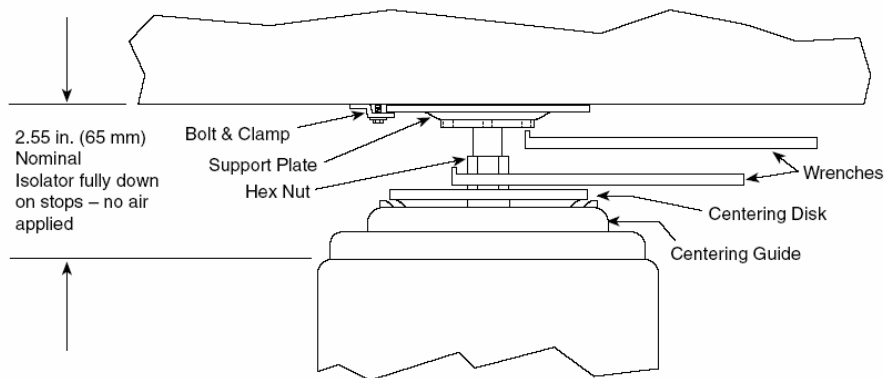

Figure 4 — Level Adjustment of Isolators

4. When the table is completely level, ensure by eye that every isolator support plate is snug against the table bottom and that each centering disk is centered in its guide (Figure 4).
5. Use the level to confirm that the table top is still level and equally supported by all isolator support plates. Tighten all isolator clamp bolts snugly to secure the table to the isolators.
6. Loosen the two screws securing each leveling valve to its bracket. Slide the valve body until it is approximately 0.060 inches (1.5mm) below the bottom of the table. Be sure the valve is not tilted, then tighten the screws (Figure 6).

## **2.3 Isolating the Table Top**

---

### **2.3.1 Installing Leveling Valves**

The IPV leveling valve is shown in Figure 5. Three valves are used in all systems, regardless of the number of isolators, as only three points are required to determine a plane. The leveling valve locations are selected such that they form the largest triangle possible under the table. The larger the triangle, the more stable the system will be. When two or more isolators are controlled by the same valve, they act as a single large isolator supporting the table at the center of force of the several isolators. The floating height of the system is determined at the valve position. Therefore, ideally, the valves should be located at the center of force of the isolators they control. In practice, however, simply grouping the isolators and their control valves is sufficient. The groups of isolators and their valves act as three legs for the system. The center of gravity of the combined table and payload must be within the triangle formed by the centers of force of the isolator groups for the system to float. Figure 8 shows valve and isolator arrangements for rectangular tables. Complex table shapes require isolator and valve layouts designed specifically for each application.

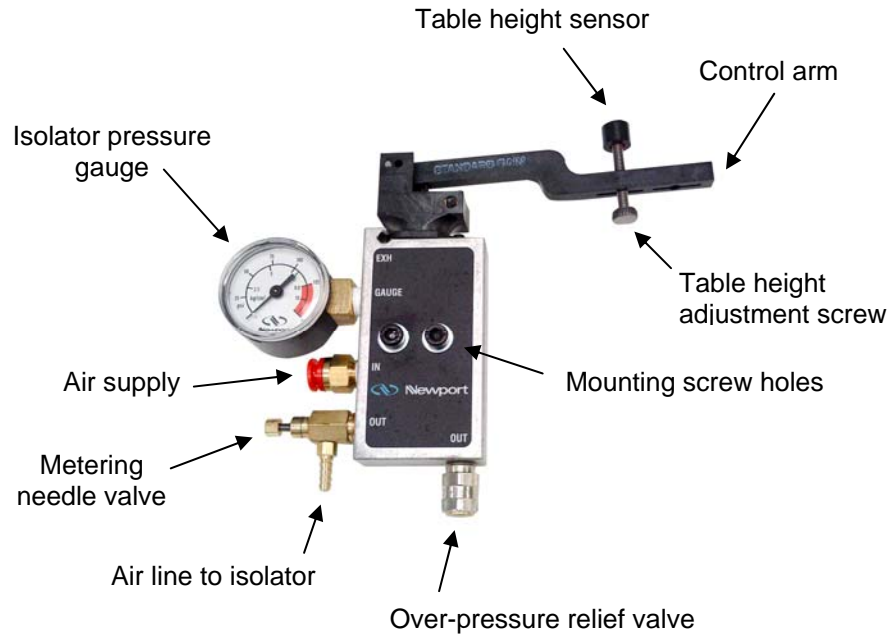

Figure 5 — IPV Leveling Valve



Figure 6 — Valves attaching to isolator

The valves should be attached to the isolators as shown in Figure 6 after installing the table top.

1. Set the table height adjustment screw on each valve to the center of its travel (Figure 6).
2. Attach the leveling valve to the isolators as shown in Figure 6. Secure the valve to the bracket using the two mounting screws and the nutplate.

Position the valve at the bottom of the bracket slots until after the table is installed and leveled.

3. Rotate the control arm on valves “A” in Figure 7 so that they point towards the nearest corner of the table.
4. Rotate the control arm on valve “B” in the figure so that it points toward the table’s center, midway between the isolators that it controls.
5. For systems with more than four isolators, use the same basic setup just described: Two valves control the height of the two end corners (A & A) while the third valve (B) controls the height of the opposite end (Figure 8).

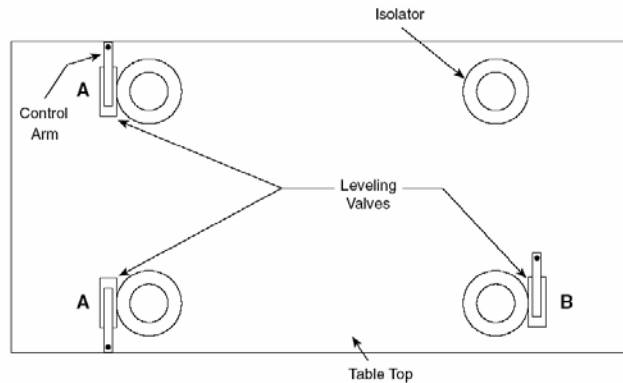

Figure 7 — Orientation of Control Arm

### 2.3.2 Connecting Air Lines

1. Connect air lines to the isolators as shown in Figure 8. When cutting tubing, be sure the ends are round and cut squarely. This is best done with a single edge razor blade (scissors will deform the tubing, causing leaks). The connections are detailed in Figures 8, 9 and 10.
  - a. Use translucent tubing to connect the air supply to each of the leveling valves. Use “Tee” connectors as required. Press the free end of the tubing into the yellow collar of the valve’s “IN” connector. Be sure the connection is firm by tugging on the tube.
  - b. Connect a length of grey tubing (supplied with the valves for use on the valve barb fitting) between the hose barb on the valve and the inlet connector on the isolator (Figure 9). If more than one isolator is supplied by a valve, use “Tee” connectors as required (Figure 10). Connect the grey tube from the valve to the “Tee” and use translucent tubing between the “Tee” and each isolator.



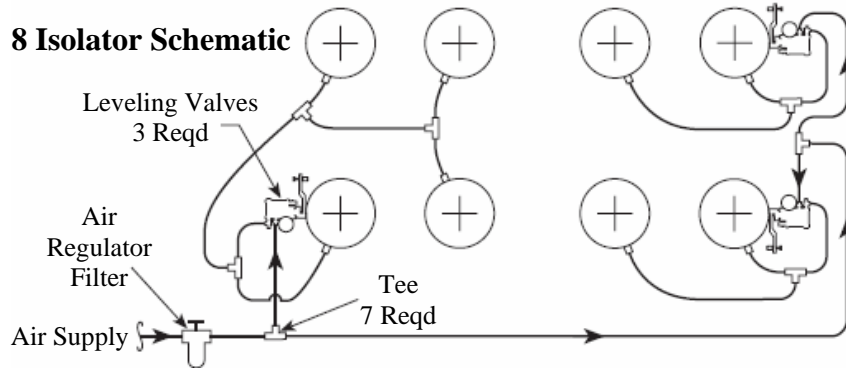
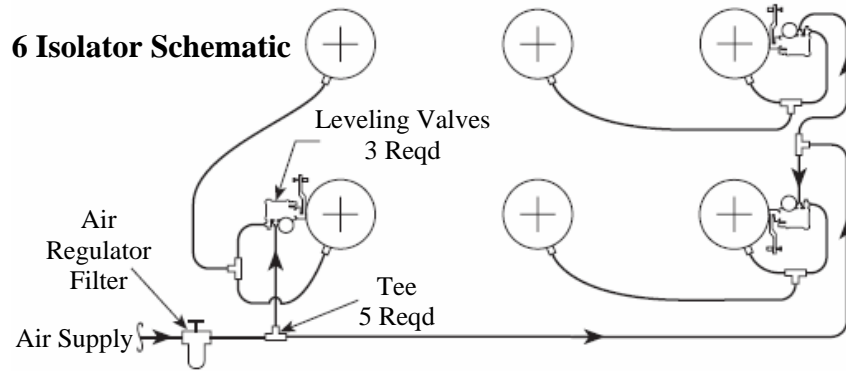
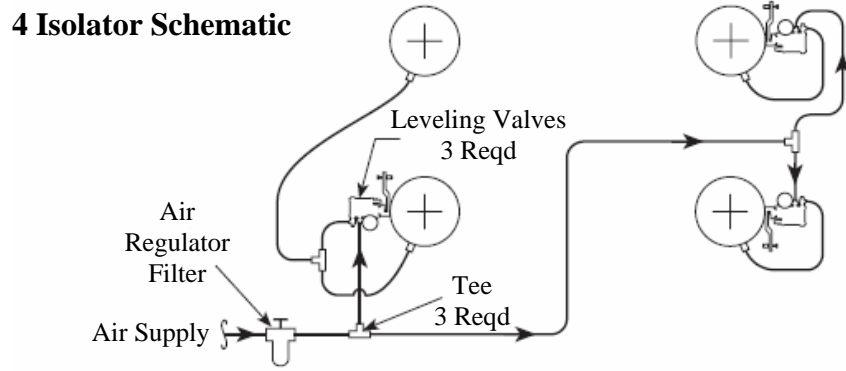
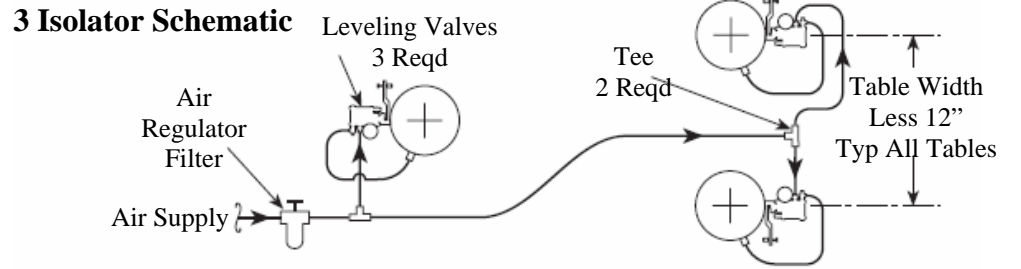

Figure 8 — Air Line Routing



Figure 9 — Detail of Valve Connections, Single Isolator

2. Close the metering needle valve (Figure 9) on each valve and then open it  $\frac{1}{2}$  turn for each isolator that is connected to it. For example, if the valve controls two isolators, the needle valve is opened 1 full turn. [Please note: If you have a minimum load on your optical table top, open the metering valve about  $\frac{1}{8}$  –  $\frac{1}{4}$  of a turn.]
3. Turn on the air supply and adjust the regulator for the pressure calculated using the formula given in Section 1.6. This pressure must not exceed 95psig (6.7 kg/cm<sup>2</sup>).



Figure 10— Detail of Valve Connections, Two Isolators

4. Check all connections for leaks. Correct or repair any leaks before proceeding.
5. If the table does not float within several minutes, increase the air pressure until the table floats or adjust the value height sensors to hold

the control arms further down. Confirm that the needle valves are open  $\frac{1}{2}$  turn per isolator supplied.

NOTE: If the table oscillates after it floats, decrease the air pressure or close the needle valves slightly.

6. In clean room applications the “EXH” (exhaust) port on the valves may be connected to the clean room vacuum system to capture the valve exhaust.

NOTE: Exhaust must be routed to a vacuum system. Backpressure in the tubing will cause the exhaust air to leak from the valve.

### 2.3.3 Adjusting Leveling Valve Sensors

1. After the table floats, check the position of the centering guide and flange of all isolators (Figure 11). The gap between the guide and flange should be  $\frac{1}{4}'' \pm \frac{1}{16}''$  (6mm  $\pm$  1.5mm). The center of the isolator centering disk should be aligned with the float height indicator tabs (Figure 11).
2. Adjust the Table Height sensor screw of each isolator (Figure 5) as required to obtain this gap. When all isolators are adjusted, re-check the level of the table. NOTE: this step should require only minor adjustments. Do not move the small set screw near the pivot of the valve control arm.
3. If the table is no longer level, you may have to remove the air pressure and re-adjust the height of the isolator support plates as described in Section 2.
4. Verify that the table is freely floating on the isolators. Move the table gently from side-to-side about  $\frac{1}{8}''$ . You should not encounter any resistance. Re-check by moving the table up and down the same amount. Again, there should be no restriction of movement.
5. Push one corner of the table down approximately  $\frac{1}{8}''$  and release it. The table should return to the original position within less than 4 seconds. Response time may be adjusted as described in Section 3.2.

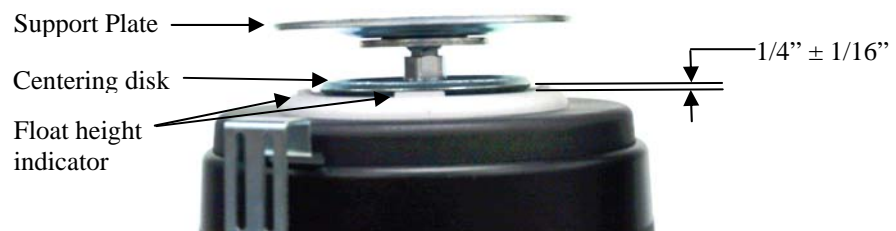

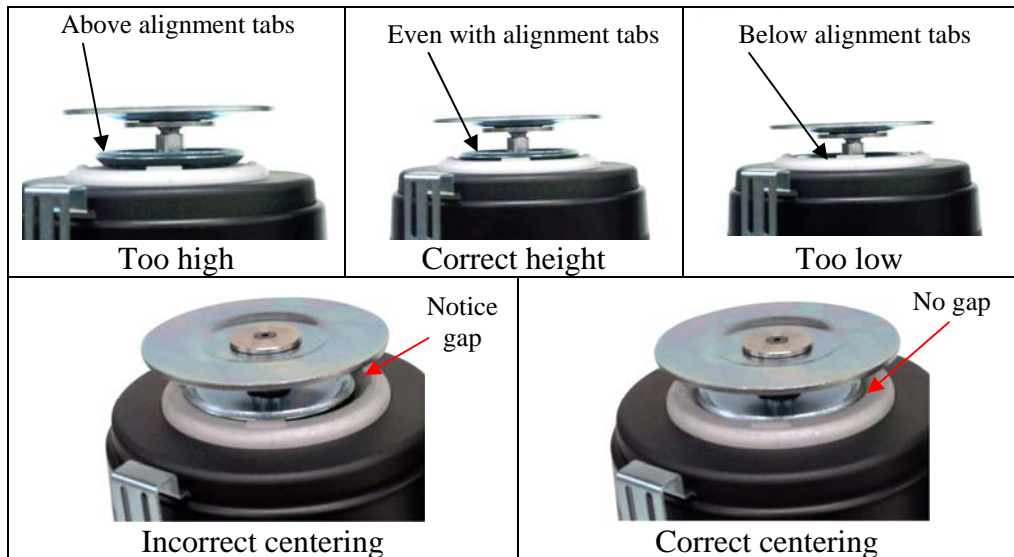

Figure 11— Floating Height Adjustment and centering

## 2.4 Installing tables with the Doubler Interface

The following instructions are applicable only to those tables equipped with the Doubler Interface. Figure 12 shows a typical Doubler Interface System.

1. Use the procedures in Section 2.1.2 and 2.3.1 to assemble the isolators for both table sections.
2. Carefully uncrate each table top, noting the correct orientation indicated on the crates. Carefully check the doubler faces for any damage that might prevent them from fitting tightly together.

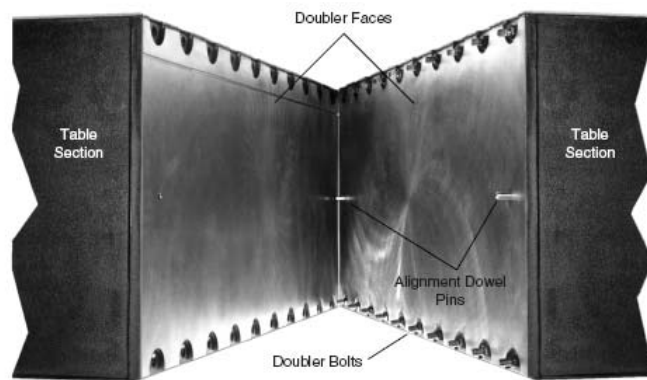



Figure 12— Typical Double Interface System

3. Position the isolators for one table section as described in Section 2.1.2. Install valves on the appropriate isolators as shown in Figure 8.
4. Install the first table section on the isolators as described in Section 2.1.3.

NOTE: It may be necessary to use jack stands to support the first table section if fewer than four isolators are located under the section.

5. Position the second table section on three jack stands mounted on dollies. Adjust the position of the table so that it is at the same height as, and adjacent to, the first table section.
6. Align the two table sections using a straight edge. Carefully roll the second table section toward the first so that the alignment dowel pins engage in their mating holes. Be sure the bolts are aligned with their corresponding holes.
7. Draw the two table sections together approximately  $\frac{1}{8}$  inch (5mm) using the two outermost top bolts.

	<b>CAUTION</b> <b>Do not force the bolts. The second table section should be easily pulled up to the first. Figure 2.13 shows correct bolt head position during assembly.</b> <b>Do not cause the first table section to shift sideways on its isolators. Doing so could damage the isolators.</b>
---	--

8. Tighten all of the bolts until they are finger-tight or until they just begin to move the table sections together. Do not force or over-tighten the bolts.
9. Repeat steps G and H until the two table sections are completely drawn together.
10. When all bolts are snug, apply a final torque of 60 pound-feet (80 N-M) to all bolts using the sequence shown in Figure 13.
11. Jack up the assembled table as required to install the remaining isolators and leveling valves. Install the isolators and valves as described in Section 2.1.
12. Remove the jack stands and level the table as described in Section 2.3.
13. Install the air lines and float the table as described in Section 2.3.

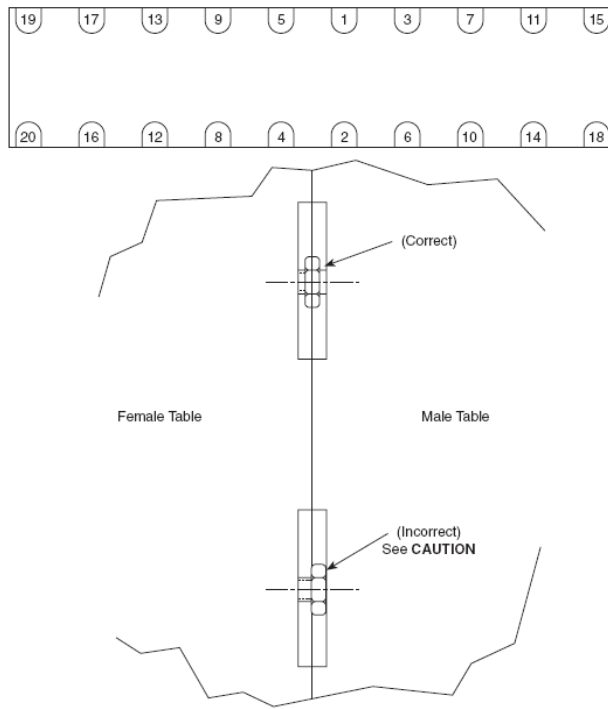

Figure 13— Double Bolt Tightening Sequence

## 3 Operation

### 3.1 Principles of Operation

The S-2000 Stabilizer™ Isolators provide one of the best methods of vibration isolation for critical applications. The system operates on the principle of air pistons, which are equivalent of soft springs. The main advantage of the Newport system over other designs are low vertical resonant frequency with low amplification at resonance (Q) and a Pendulum™ horizontal decoupling system for effective isolation from low amplitude vibration.

Newport optical tables provide a working surface that is statically rigid with high internal tuned damping for high dynamic rigidity and minimal response to environmental disturbances.

The leveling valves provided with the system control the height of the table to within  $\pm 0.01$ " (0.3mm) accuracy. This tolerance is adequate for most applications. More accurate valves are available for specialized applications.

### 3.2 Performance Adjustments

Once the system is assembled and the table floating, it is possible to make minor adjustments to suit your individual needs. These adjustments involve the system air pressure, the control arms, and needle valves.



#### WARNING

**Once the table is floating, keep fingers away from the area between the centering guide and outer clamp of the isolators. Any object between these points may be caught if the table load or air supply changes, causing personal injury.**

1. Stabilizing high center-of-mass loads: If your load has a high center of mass or if the load is particularly heavy, the table may oscillate. In this case, lower the system pressure or close the needle valves slightly. This may improve stability and reduce the oscillation or “hunting”.
2. A rule of thumb for determining high center of gravity (C-G) system stability is shown in Figure 14. If the combined center of gravity of the payload and table top is within the “stable region”, the system will be stable. If the combined C-G is inside the “may be stable region”, the

system may be stable. If the combined C-G is outside both regions, the system will probably be unstable.

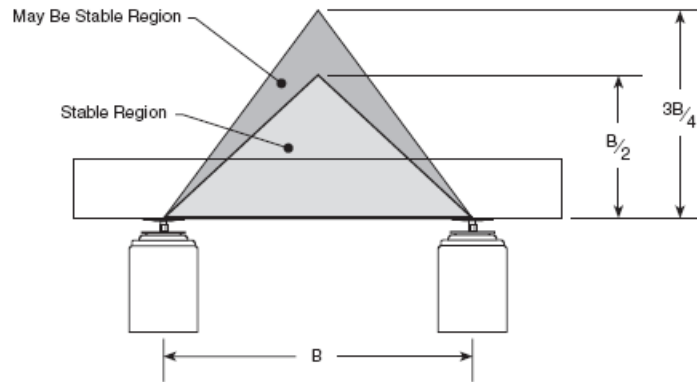

Figure 14— System Stability

3. Improving leveling response times: If the system is stable, the re-leveling response time may be decreased by increasing the system pressure. In addition, the needle valves may be opened until the system oscillates and then closed slightly. This is desirable if components are moving over the surface of the table.

For systems where the loads are seldom changed, slower re-leveling may be beneficial. This is accomplished by closing the needle valves slightly and/or decreasing the system pressure.

All needle valves should be opened the same amount for each isolator that they supply.

4. Table loads and/or load positions change: If the loads are moving or changing significantly, the control arms may require adjustment. Each time the load is changed, check the relationship of the centering guide to the flange on each isolator. If the desired  $\frac{1}{4}$  inch is not maintained, adjust the overall system pressure and/or the sensor positions.

Newport Vibration Control Systems require little maintenance. No periodic maintenance is required.

### 3.3 Maintenance

#### 3.3.1 Cleaning

Newport optical table tops are made of 400 series stainless steel. This material is relatively corrosion resistant. It may be cleaned by applying non-abrasive liquid household cleaner to a rag and wiping the table top. Avoid abrasive cleaners as they will foul the mounting holes.

All other surfaces on the table top or isolator system may be cleaned in the same manner.



---

**3.3.2 Air Quality**

Oil, water, or debris in the air supply may contaminate the leveling valves or isolator damping system and degrade performance. Use of the Newport model ARF Air Regulator and Filter in the air supply will prevent this occurrence. The filter does require occasional cleaning.

## 4 Troubleshooting

### 4.1 Table Top Does Not Float

---

Use the following procedure if the table top does not float, or lift up, when pressure is applied to the isolators.

1. Ensure that the supply pressure is 5–10 psig (0.4–0.7kg/cm<sup>2</sup>) above the pressure reading of any of the leveling valves. If the load is increased, the pressure should be increased to maintain the difference between supply and valve pressure. Refer to Section 1.6.
2. Check to see if all air lines are connected properly and the supply pressure is adequate (see step 1). Refer to Figures 8, 9, and 10.
3. Be sure that the needle valves are not closed completely.
4. Check each leveling valve for clogging. To do this, press the control arm down. Air should flow into the isolator, accompanied by the familiar sound of moving air. Repair or replace any clogged valve. Use the ARF filter/regulator to prevent this situation.

### 4.2 Poor Isolation Performance

---

The following may lead to poor isolation performance of your system.

1. Vibration may be transmitted to the table through direct physical contact of equipment with external sources of vibration.
2. Isolators that float too high, too low, or are not centered may conduct floor vibration to the table top. Refer to Section 2.3.2. (Figure 11) Centered isolators will remain centered unless the table and isolators are moved relative to each other.
3. Equipment on the table may be vibrating at a resonant frequency of other components. Improve the rigidity of the mounting for that equipment or remove that item from the table.
4. Non-level floor may prevent the horizontal isolation system from functioning properly (see Section 1.5).

---

### 4.3 Table Top Oscillates

---

If the table top oscillates or “hunts”, you may have a set up with a high center of mass. Refer to the information in Section 3.2 or consult your Newport representative or Newport Corporation for further assistance.

### 4.4 System Leaks Air Constantly

---

All Newport isolators and valves are pressure leak tested prior to shipment. Check all tubing connections for leaks with soapy water. Tubing that is crushed out of round or that is not cut squarely may not seal in the push-in fittings. Use a single edge razor blade to cut the tubing cleanly (refer to Section 2.3.2). If testing with soapy water indicates that either the isolator or valve are leaking contact Newport Customer Service.

### 4.5 Oil Leak From Isolator

---

Damping oil may leak from the isolator if it is inverted or tilted more than 45 degrees. If more than  $\frac{1}{8}$  cup (30ml) of oil is lost, add additional oil (available from Newport Corporation) as directed in Section 4.6. Losses of less than  $\frac{1}{8}$  cup will not affect the isolator performance. Total volume of damping oil per isolator is approximately  $\frac{1}{2}$  cup (125ml).

### 4.6 Adding Damping Oil

---

If the isolator loses damping oil, additional oil may be added as follows:

1. Remove the air pressure from the isolator and allow the piston to retract. Ensure that the remaining isolators will support the table or use a jack stand to replace the isolator to be serviced. Loosen the three bolts securing the support plate to the bottom of the table, and slide the isolator from under the system.



#### **WARNING**

**The table top is heavy and may cause severe personal injury if it falls! Be sure it is properly supported before getting underneath the table top or removing the isolator.**

2. Measure the height of the support plate relative to the centering disk (Figure 2.4). Record this distance so that the isolator may be returned to its normal position.
3. Unscrew the isolator support screw (right-hand thread) and remove the plate and jack screw from the piston assembly.
4. Use a funnel to add damping oil through the support shaft hole until the oil level is approximately  $\frac{1}{4}$ " (6.4mm) from the bottom of the piston. Allow time for the viscous oil to settle before measuring the oil level.

5. Use a clean, small diameter rod to check the level. When checking the level, be sure the rod sits on the bottom of the piston and not on the narrow ledge at the bottom of the support shaft.
6. Reverse Steps 2 and 3 to re-assemble the isolator. Return the support plate to the position noted in Step 2.
7. Reinstall the isolator and apply air pressure. Make any required adjustments to return the system to operation.

---

## 5 Factory Service

To obtain information concerning factory service, contact Newport Corporation or your Newport representative. Please have the following information available.

1. Model number.
2. Purchase order number.
3. Complete description of the problem.

If components are to be returned to Newport Corporation, you will be given a Return Number, which you should reference in your shipping documents.

Please fill out the service form located on the next page, and have the information ready when contacting Newport Corporation. Include the completed service form with any parts or components that are returned.